



agriduarte
indústria



CAPINADEIRAS

ROTARY CUTTERS

GYROBROYEURS



FICHA TÉCNICA | FICHE TECHNIQUE | TECHNICAL DATASHEET
CAPINADEIRAS (CORTA-MATOS)
GYROBROYEURS
ROTARY CUTTERS

• CPL 1.0

SÉRIE MINI | SÈRIE MINI | MINI SERIES

| MODELO | MODÈLE | MODEL | CPL 90 | CPL 1.0 | CPL 1.1 |
|---|--|-------------------------------------|------------|------------|------------|
| CÓDIGO | CODE | CODE | 470070090 | 470070100 | 470070110 |
| LARGURA DE TRABALHO (mm) | LARGEUR DE TRAVAIL (mm) | WORKING WIDTH (mm) | 900 | 1000 | 1100 |
| LARGURA EXTERIOR (mm) | LARGEUR EXTERIEUR (mm) | OUTER WIDTH (mm) | 1000 | 1100 | 1200 |
| SISTEMA DE CORTE- CORRENTES | SYSTÈME DE COUPE – CHAÎNES | CUTTING SYSTEM – CHAINS | 2 - G80-13 | 2 - G80-13 | 2 - G80-13 |
| SISTEMA DE ENGATE DE CORRENTES – UNIÃO RÁPIDA | SYSTÈME DE COUPLAGE DES CHAINES - UNION RAPIDE | CHAINS COUPLING SYSTEM - FAST UNION | OK | OK | OK |
| POTÊNCIA RECOMENDADA - TRATOR (hp) | PUISSANCE RECOMMANDÉE - TRACTEUR (hp) | RECOMMENDED POWER – TRACTOR (hp) | 18 - 30 | 20 - 35 | 20 - 40 |
| CARDAN | CARDAN | CARDAN | CAT 4-FSV | CAT 4-FSV | CAT 4-EMB |
| GRUPO DE ENGRENAGENS (hp) | GROUPE ENGRENAGE (hp) | GEAR GROUP (hp) | AGD30 (30) | AGD30 (30) | AGD30 (30) |
| ENGATE - CAVILHAS DE 3º PONTO CAT. I/II | ATTELAGE - BOULONS 3ème POINT CAT. I/II | COUPLING - PINS 3rd POINT CAT. I/II | OK | OK | OK |
| DISCOS – DIAMETRO (mm) | DISQUES - DIAMETRE (mm) | DISCS - DIAMETER (mm) | 250 | 300 | 300 |
| ESPESSURA DA ESTRUTURA (mm) | ÉPAISSEUR DE LA STRUCTURE (mm) | STRUCTURE THICKNESS (mm) | 4 | 4 | 4 |
| PESO (kg) | POIDS (kg) | WEIGHT (kg) | 165 | 180 | 220 |

NOTAS | NOTES | NOTES: Cor do Equipamento: Vermelho RAL 3020 | Couleur de l'Équipement: Rouge RAL 3020 | Main Color of Equipment: Red RAL 3020;

SISTEMA DE CORTE
SYSTÈME DE COUPE
CUTTING SYSTEM



2 - G80 - 13

GRUPO DE ENGRENAGENS
GROUPE D'ENGRENAGES
GEAR GROUP



AGD30
 AGRIDUARTE (30 hp)

SISTEMA DE LIMITAÇÃO DE ESFORÇO NO CARDAN
SYSTÈME DE LIMITATION DE L'EFFORT EN CARDAN
SYSTEM OF LIMITATION OF EFFORT IN CARDAN



FSV **EMB**



• CPL 1.3

SÉRIE FLORESTAL | SÈRIE FORESTIÈRE | FOREST SERIES

| MODELO | MODÈLE | MODEL | CPL 1.2 | CPL 1.3 | CPL 1.4 |
|---|--|-------------------------------------|------------|------------|------------|
| CÓDIGO | CODE | CODE | 470070120 | 470070130 | 470070140 |
| LARGURA DE TRABALHO (mm) | LARGEUR DE TRAVAIL (mm) | WORKING WIDTH (mm) | 1200 | 1300 | 1400 |
| LARGURA EXTERIOR (mm) | LARGEUR EXTERIEUR (mm) | OUTER WIDTH (mm) | 1300 | 1400 | 1500 |
| SISTEMA DE CORTE- CORRENTES | SYSTÈME DE COUPE – CHAÎNES | CUTTING SYSTEM – CHAINS | 2 - G80-13 | 2 - G80-16 | 2 - G80-16 |
| SISTEMA DE ENGATE DE CORRENTES – UNIÃO RÁPIDA | SYSTÈME DE COUPLAGE DES CHAINES - UNION RAPIDE | CHAINS COUPLING SYSTEM - FAST UNION | OK | OK | OK |
| POTÊNCIA RECOMENDADA - TRATOR (hp) | PUISSANCE RECOMMANDÉE - TRACTEUR (hp) | RECOMMENDED POWER – TRACTOR (hp) | 30 - 45 | 35 - 55 | 40 - 60 |
| CARDAN | CARDAN | CARDAN | CAT 4-EMB | CAT 4-EMB | CAT 5-EMB |
| GRUPO DE ENGENHAGENS (hp) | GROUPE ENGRENAGE (hp) | GEAR GROUP (hp) | AGD30 (30) | AGD30 (30) | AGD60 (60) |
| ENGATE - CAVILHAS DE 3º PONTO CAT. I/II | ATTELAGE - BOULONS 3ème POINT CAT. I/II | COUPLING - PINS 3rd POINT CAT. I/II | OK | OK | OK |
| DISCOS – DIAMETRO (mm) | DISQUES - DIAMETRE (mm) | DISCS - DIAMETER (mm) | 300 | 300 | 300 |
| ESPESSURA DA ESTRUTURA (mm) | ÉPAISSEUR DE LA STRUCTURE (mm) | STRUCTURE THICKNESS (mm) | 6 | 6 | 6 |
| PESO (kg) | POIDS (kg) | WEIGHT (kg) | 250 | 310 | 340 |



NOTAS | NOTES | NOTES: Cor do Equipamento: Vermelho RAL 3020 | Couleur de l'Équipement: Rouge RAL 3020 | Main Color of Equipment: Red RAL 3020;

SISTEMA DE CORTE
SYSTÈME DE COUPE
CUTTING SYSTEM



2 - G80 - 13 **2 - G80 - 16**

GRUPO DE ENGENHAGENS
GROUPE D'ENGENHAGENS
GEAR GROUP

AGD30 **AGD60**
 AGRIDUARTE (30 hp) AGRIDUARTE (60 hp)

SISTEMA DE LIMITAÇÃO DE ESFORÇO NO CARDAN
SYSTÈME DE LIMITATION DE L'EFFORT EN CARDAN
SYSTEM OF LIMITATION OF EFFORT IN CARDAN



EMB



• CPR 1.5

FICHA TÉCNICA | FICHE TECHNIQUE | TECHNICAL DATASHEET

CAPINADEIRAS (CORTA-MATOS)

GYROBROYEURS

ROTARY CUTTERS

SÉRIE FLORESTAL REFORÇADA | SÈRIE FORESTIÈRE RENFORCÉE | REINFORCED FOREST SERIES

| MODELO | MODÈLE | MODEL | CPR 1.3 | CPR 1.4 | CFR 1.5 | CPR 1.5 | CPR 1.6 | CPR 1.8 | CPRX 1.8 |
|---|--|-------------------------------------|------------|------------|------------|----------------|----------------|----------------|-----------------|
| CÓDIGO | CODE | CODE | 470070230 | 470070240 | 470073500 | 470070250 | 470070260 | 470070280 | 470070508 |
| LARGURA DE TRABALHO (mm) | LARGEUR DE TRAVAIL (mm) | WORKING WIDTH (mm) | 1300 | 1400 | 1500 | 1500 | 1600 | 1800 | 1800 |
| LARGURA EXTERIOR (mm) | LARGEUR EXTERIEUR (mm) | OUTER WIDTH (mm) | 1400 | 1500 | 1600 | 1600 | 1700 | 1900 | 1900 |
| SISTEMA DE CORTE - CORRENTES | SYSTÈME DE COUPE - CHÂÎNES | CUTTING SYSTEM - CHAINS | 4 - G80-16 | 4 - G80-16 | 2 - G80-16 | 4 - G80-20 | 4 - G80-20 | 4 - G80-20 | 4 - G80-20 |
| SISTEMA DE ENGATE DE CORRENTES - UNIÃO RÁPIDA | SYSTÈME DE COUPLAGE DES CHAINES - UNION RAPIDE | CHAINS COUPLING SYSTEM - FAST UNION | OK | OK | OK | OK | OK | OK | OK |
| POTÊNCIA RECOMENDADA - TRATOR (hp) | PUISSANCE RECOMMANDÉE - TRACTEUR (hp) | RECOMMENDED POWER - TRACTOR (hp) | 40 - 60 | 50 - 70 | 50 - 70 | 60 - 80 | 70 - 90 | 80 - 110 | 90 - 120 |
| CARDAN | CARDAN | CARDAN | CAT 5-EMB | CAT 5-EMB | CAT 5-EMB | CAT 6-EMB | CAT 6-EMB | CAT 8-EMB | CAT 9-EMB |
| GRUPO DE ENGENHAGENS (hp) | GROUPE ENGRENAGE (hp) | GEAR GROUP (hp) | AGD60 (60) | AGD60 (60) | AGD60 (60) | BYPY 3070 (75) | BYPY 3070 (75) | BYPY 3070 (75) | BYPY 3100 (100) |
| ENGATE - CAVILHAS DE 3º PONTO CAT. I/II | ATTELAGE - BOULONS 3ème POINT CAT. I/II | COUPLING - PINS 3rd POINT CAT. I/II | OK | OK | OK | OK | OK | OK | OK |
| DISCOS - DIAMETRO (mm) | DISQUES - DIAMETRE (mm) | DISCS - DIAMETER (mm) | 300 | 370 | 370 | 370 | 370 | 480/HB 450 | 480/HB 450 |
| ESPESSURA DA ESTRUTURA (mm) | ÉPAISSEUR DE LA STRUCTURE (mm) | STRUCTURE THICKNESS (mm) | 8 | 8 | 6 | 8 | 8 | 8 | 10 |
| PESO (kg) | POIDS (kg) | WEIGHT (kg) | 340 | 385 | 380 | 470 | 510 | 650 | 750 |

NOTAS | NOTES | NOTES: Cor do Equipamento: Vermelho RAL 3020 | Couleur de l'Équipement: Rouge RAL 3020 | Main Color of Equipment: Red RAL 3020;

SISTEMA DE CORTE
SYSTÈME DE COUPE
CUTTING SYSTEM

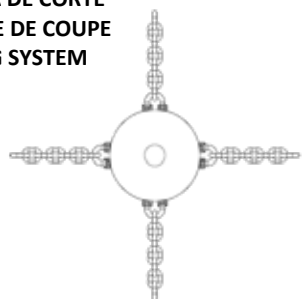

4 - G80 - 16

4 - G80 - 20

GRUPO DE ENGENHAGENS
GROUPE D'ENGRENAGES
GEAR GROUP



AGD60

AGRIDUARTE (60 hp)



BYPY 3070

BONDIOLI PAVESI (75 hp)



BYPY 3100

BONDIOLI PAVESI (100 hp)

SISTEMA DE LIMITAÇÃO DE ESFORÇO NO CARDAN
SYSTÈME DE LIMITATION DE L'EFFORT EN CARDAN
SYSTEM OF LIMITATION OF EFFORT IN CARDAN



EMB



CAPINADEIRAS (CORTA-MATOS)
GYROBROYEURS
ROTARY CUTTERS

• CPR 1.5 H

SÉRIE FLORESTAL DESCENTRÁVEL | SÉRIE FORESTIÈRE DESCENTRABLE | DESCENTRABLE FOREST SERIES

| MODELO | MODÈLE | MODEL | CPL 1.3 H | CPL 1.4 H | CFR 1.5 H | CPR 1.5 H | CPR 1.8 H |
|--|--|--|------------|------------|------------|----------------|----------------|
| CÓDIGO | CODE | CODE | 470070430 | 470070440 | 470070460 | 470070450 | 470070480 |
| LARGURA DE TRABALHO (mm) | LARGEUR DE TRAVAIL (mm) | WORKING WIDTH (mm) | 1300 | 1400 | 1500 | 1500 | 1800 |
| LARGURA EXTERIOR (mm) | LARGEUR EXTERIEUR (mm) | OUTER WIDTH (mm) | 1400 | 1500 | 1600 | 1700 | 1900 |
| DESCENTRAMENTO (DIR / ESQ) (mm) | DÉPLACEMENT (DROITE / GAUCHE) (mm) | DISPLACEMENT (RIGHT / LEFT) (mm) | 200 | 200 | 250 | 250 | 250 |
| SISTEMA DE CORTE - CORRENTES | SYSTÈME DE COUPE - CHAÎNES | CUTTING SYSTEM - CHAINS | 2 - G80-16 | 2 - G80-16 | 2 - G80-16 | 4 - G80-20 | 4 - G80-20 |
| SISTEMA DE ENGATE DE CORRENTES - UNIÃO RÁPIDA | SYSTÈME DE COUPLAGE DES CHAINES - UNION RAPIDE | CHAINS COUPLING SYSTEM - FAST UNION | OK | OK | OK | OK | OK |
| POTÊNCIA RECOMENDADA - TRATOR (hp) | PUISSANCE RECOMMANDÉE - TRACTEUR (hp) | RECOMMENDED POWER - TRACTOR (hp) | 35 - 55 | 40 - 60 | 50 - 70 | 60 - 80 | 80 - 110 |
| LINHA HIDRAULICA DE ALIMENTAÇÃO RECOMENDADA (DUPLO EFEITO) | LIGNE DE PUISSANCE HYDRAULIQUE RECOMMANDÉE (EFFET DOBLE) | RECOMMENDED HYDRAULIC POWER LINE DOBLE EFFECT) | 1 | 1 | 1 | 1 | 1 |
| CARDAN | CARDAN | CARDAN | CAT 4-EMB | CAT 5-EMB | CAT 5-EMB | CAT 6-EMB | CAT 8-EMB |
| GRUPO DE ENGENHAGENS (hp) | GROUPE ENGRENAGE (hp) | GEAR GROUP (hp) | AGD3 (30) | AGD6 (60) | AGD6 (60) | BYPY 3070 (75) | BYPY 3070 (75) |
| ENGATE - CAVILHAS DE 3º PONTO CAT. I/II | ATTELAGE - BOULONS 3ème POINT CAT. I/II | COUPLING - PINS 3rd POINT CAT. I/II | OK | OK | OK | OK | OK |
| DISCOS – DIAMETRO (mm) | DISQUES - DIAMETRE (mm) | DISCS - DIAMETER (mm) | 300 | 300 | 370 | 370 | 480/HB 450 |
| ESPESSURA DA ESTRUTURA (mm) | ÉPAISSEUR DE LA STRUCTURE (mm) | STRUCTURE THICKNESS (mm) | 6 | 6 | 6 | 8 | 8 |
| PESO (kg) | POIDS (kg) | WEIGHT (kg) | 360 | 390 | 430 | 520 | 815 |

NOTAS | NOTES | NOTES: Cor do Equipamento: Vermelho RAL 3020 | Couleur de l'Équipement: Rouge RAL 3020 | Main Color of Equipment: Red RAL 3020;

SISTEMA DE CORTE
SYSTÈME DE COUPE
CUTTING SYSTEM

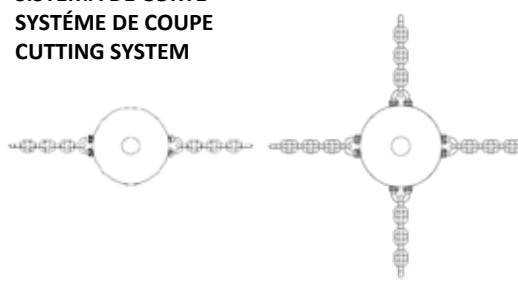

2 - G80 - 16 **4 - G80 - 20**

GRUPO DE ENGENHAGENS
GROUPE D'ENGRENAGES
GEAR GROUP



AGD30
AGRIDUARTE (30 hp)

AGD60
AGRIDUARTE (60 hp)

BYPY 3070
BONDIOLI PAVESI (75 hp)

SISTEMA DE LIMITAÇÃO DE ESFORÇO NO CARDAN
SYSTÈME DE LIMITATION DE L'EFFORT EN CARDAN
SYSTEM OF LIMITATION OF EFFORT IN CARDAN



EMB



SISTEMA DE ENGATE DE 3º PONTO OSCILANTE;
 SYSTÈME DE RACCORDEMENT 3e POINT OSCILLANT;
 3rd POINT CONNECTION SYSTEM OSCILLATING;

ENGATE - CAVILHAS DE 3º PONTO CAT. I/II;
 ATTELAGE - BOULONS 3ème POINT CAT. I/II;
 COUPLING - PINS 3rd POINT CAT. I/II;

TRASEIRA CURVA QUE ACOMPANHA A ÁREA DE CORTE E FACILITA A UTILIZAÇÃO;
 COURBE ARRIÈRE ACCOMPAGNANT LA ZONE DE COUPE ET FACILITE L'UTILISATION;
 BACK CURVE ACCOMPANYING THE CUTTING AREA AND FACILITATES THE USE;

ESTRUTURA EM AÇO REFORÇADA PELA FACE SUPERIOR;
 STRUCTURE D'ACIER RENFORCÉE PAR LE FACE SUPÉRIEURE;
 STRUCTURE OF STEEL REINFORCED BY UPPER FACE;





PROTEÇÕES ANTI PROJEÇÕES À FRENTE E ATRÁS;
 PROTECTIONS ANTI PROJECTIONS AVANT ET ARRIÈRE;
 PROTECTIONS ANTI PROJECTIONS TO FRONT AND BACK;

PATINS COM REGULAÇÃO DE ALTURA DE CORTE;
 PATINS AVEC AJUSTEMENT DE HAUTEUR DE COUPE;
 SKATES WITH CUTTING HEIGHT ADJUSTMENT;

SISTEMA DE ENGATE RÁPIDO DE CORRENTES DE CORTE;
 SYSTÈME RAPIDE ATTELAGE CHAINES DE COUPE;
 QUICK HITCH SYSTEM OF CUTTING CHAINS;

GRUPO DE ENGENHAGENS REFORÇADO E DE ALTA QUALIDADE;
 GROUPE DE ROUES RENFORCÉES ET DE GRANDE QUALITÉ;
 GEARS GROUP STRENGTHENED AND HIGH QUALITY;

PATINS COM GEOMETRIA DE CONTACTO QUE PROMOVE UM DESLIZAMENTO FÁCIL;
 PATINS AVEC GÉOMÉTRIE DE CONTACT QUI FAVORISE LE GLISSEMENT FACILE;
 SKATES WITH CONTACT GEOMETRY THAT PROMOTES EASY SLIP;

| | MOD. EXTRA | DESIGNAÇÃO | DÉSIGNATION | DESIGNATION |
|---|------------|---|--|---|
|  | CRD - SRL | CARDAN COM SISTEMA RODA LIVRE | CARDAN AVEC SYSTÈME DE ROUE LIBRE | CARDAN W/OVERRUNNING CLUTCHES SYSTEM |
|  | DHB450CPR | DISCO EM AÇO DE ALTA RESISTENCIA A DESGASTE HB450 (CPR) - (MODELOS: CPR) | DISQUE EN ACIER DE HAUTE RÉSISTENCE À PORTER HB450 (CPR) - (MODÈLES: CPR) | DISK HIGH RESISTANCE TO WEAR STEEL HB450 (CPR) - (MODELS: CPR) |
|  | BHB450 | BASE DE CARTER EM AÇO DE ALTA RESISTENCIA A DESGASTE HB450 (ADICIONAR AO VALOR BASE DA MÁQUINA) | PLAQUE DE BASE EN ACIER DE HAUTE RÉSISTENCE À PORTER HB450 (AJOUTER AU VALEUR DE BASE DE LA MACHINE) | SHEET BASE HIGH RESISTANCE TO WEAR STEEL HB450 (ADD TO BASE VALUE OF MACHINE) |
|  | FC-CPLM | FACAS DE CORTE - SÉRIE MINI | COUTEAUX DE COUPE - SÉRIE MINI | CUTTING KNIVES - MINI SERIES |
| | FC-CPL | FACAS DE CORTE - SÉRIE FLORESTAL | COUTEAUX DE COUPE - SÉRIE FORESTIÉR | CUTTING KNIVES - FOREST SERIES |
| | FC-CPR | FACAS DE CORTE - SÉRIE FLORESTAL REFORÇADA | COUTEAUX DE COUPE - SÉRIE FORESTIÉR RENFORCÉE | CUTTING KNIVES - REINFORCED FOREST SERIES |
|  | ABR-CPR | ABATE RAMOS COM AFINAÇÃO – SÉRIE FLORESTAL REFORÇADA | RABATTEUR DE BRANCHES AVEC AJUSTEMENT - SÉRIE FORESTIÉR RENFORCÉE | DOWN BRANCHES FRAME WITH ADJUSTMENT - REINFORCED FOREST SERIES |